

High Voltage Ceramic Capacitors DC10-40kV



for EU RoHS Compliant

- All the products on this catalog are complied with EU RoHS.
- EU RoHS is "the European Directive 2002/95/EC on the Restriction of the Use of Certain Hazardous Substances in Electrical and Electronic Equipment".
- For more details, please refer to our website 'Murata's Approach for EU RoHS' (<http://www.murata.com/info/rohs.html>).

CONTENTS

1

Part Numbering	2
1 Radial Lead Type DHR Series (DC10-15kV)	3
● Specifications and Test Methods	5
● Typical Characteristics Data/Packaging	7
DHR Series ⚠Caution/Notice	8
2 Mold Type DHS N4700 Series (DC10-40kV)	10
● Specifications and Test Methods/Typical Characteristics Data	12
3 Mold Type DHS Z5V Series (DC20-40kV)	13
● Specifications and Test Methods	14
● Typical Characteristics Data	15
DHS Series ⚠Caution/Notice	16
ISO9000 Certifications	18

2

3

● Part Numbering

High Voltage Ceramic Capacitors (over 10kV)

(Part Number)

DH	R	B3	4A	101	M	2B	B
①	②	③	④	⑤	⑥	⑦	⑧

① Product ID

Product ID	
DH	High Voltage Ceramic Capacitors (over 10kV)

② Series Category

Code	Contents
R	Radial Type
S	Mold Type

First three digits of part number (①Product ID and ②Series Category) express "Series Name".

③ Temperature Characteristics

Code	Temp. Char.	Cap. Change or Temp. Coeff.	Temp. Range
B3	B	±10%	-25 to +85°C
F4	Z5V	+22%, -82%	+10 to +85°C
4E	ZM N4700	-4700±1000ppm/°C	+20 to +85°C

④ Rated Voltage

Code	Rated Voltage
4A	DC10kV
4B	DC12kV
4C	DC15kV
4D	DC20kV
4F	DC30kV
4G	DC40kV

⑤ Capacitance

Expressed by three figures. The unit is pico-farad (pF). The first and second figures are significant digits, and the third figure expresses the number of zeros which follow the two numbers.

⑥ Capacitance Tolerance

Code	Capacitance Tolerance
K	±10%
M	±20%
Z	+80%, -20%

⑦ Lead Type (DHR Series)

Code	Lead Type	Lead Spacing	Lead Diameter
2B	Straight Long	9.5mm	ø0.65mm
2F		12.7mm	ø0.8mm

⑦ Body Diameter and Terminal Type (DHS Series)

Code	Body Diameter	Terminal Type
C2	20mm	ISO M4, P0.7 Tapped Holes (Metric Screw Thread)
D2	24mm	
H2	30mm	
L2	38mm	
N2	43mm	
R2	52mm	
T2	60mm	No.8-32, NC-2B Tapped Holes (Inch Screw Thread)
CX	20mm	
DX	24mm	
HX	30mm	
LX	38mm	
NX	43mm	
RX	52mm	
TX	60mm	

⑧ Packaging

Code	Packaging
B	Bulk

High Voltage Ceramic Capacitors DC10-40kV



Radial Lead Type DHR Series (DC10-15kV)

■ Features

1. Small size
2. Coated with flame-retardant epoxy resin.

■ Applications

1. Color TV doublers and triplers
2. High voltage DC power supplies (PPCs, X-ray apparatus, air cleaner, lasers, etc.)
3. Tuning capacitor in focus circuit for display

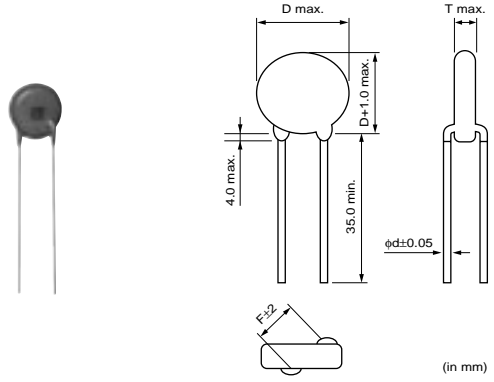

■ Marking

Nominal Body Dia.		Temp. Char.	ZM	B
		ø8mm		101 10K
ø9mm and 10mm			221K 10K•	221M 10K
ø11mm to 14mm			ZM 471K 10K	B 471M 10K
ø15mm to 18mm			102KZ M 10K 0050	102MB M 10K 0050
Temperature Characteristics	Nominal Body Dia. ø8mm		Omitted	Omitted
	Nominal Body Dia. ø9 and 10mm		Marked with • (dot)	
	Nominal Body Dia. ø11 to 14mm		Marked with code	Marked with code
	Nominal Body Dia. ø15mm min.		Marked with Z	
Nominal Capacitance			Under 100pF: Actual value, 100pF and over : Marked with 3 figures	
Capacitance Tolerance			Marked with code, omitted for nominal body diameter ø8mm and under	
Rated Voltage			Marked with code	
Manufacturer's Identification			Marked with M, omitted for nominal body diameter ø14mm and under	
Manufactured Date			Abbreviation, omitted for nominal body diameter ø14mm and under (Ex.) $\begin{matrix} 0 & 0 & 5 & 0 \\ \textcircled{1} & \textcircled{2} & \textcircled{3} & \end{matrix}$ $\textcircled{1}$: Last numeral in year $\textcircled{3}$: Fix No. $\textcircled{2}$: Number in the month	

ZM Characteristics

Part Number	Rated Voltage (kV)	Capacitance (pF)	Body Dia. D (mm)	Lead Spacing F (mm)	Body Thickness T (mm)	Lead Dia. ød (mm)
DHR4E4A101K2BB	DC10	100 ±10%	8.0	9.5	7.3	0.65
DHR4E4A151K2BB	DC10	150 ±10%	8.0	9.5	7.0	0.65
DHR4E4A221K2BB	DC10	220 ±10%	9.0	9.5	7.0	0.65
DHR4E4A331K2BB	DC10	330 ±10%	10.0	9.5	7.0	0.65
DHR4E4A471K2BB	DC10	470 ±10%	12.0	9.5	7.0	0.65
DHR4E4A681K2BB	DC10	680 ±10%	13.0	9.5	7.0	0.65
DHR4E4A102K2BB	DC10	1000 ±10%	15.0	9.5	7.0	0.65
DHR4E4B101K2BB	DC12	100 ±10%	8.0	9.5	7.3	0.65
DHR4E4B151K2BB	DC12	150 ±10%	9.0	9.5	7.3	0.65
DHR4E4B221K2BB	DC12	220 ±10%	9.0	9.5	7.3	0.65
DHR4E4B331K2BB	DC12	330 ±10%	11.0	9.5	7.3	0.65
DHR4E4B471K2BB	DC12	470 ±10%	12.0	9.5	7.3	0.65
DHR4E4B681K2BB	DC12	680 ±10%	14.0	9.5	7.3	0.65
DHR4E4B102K2BB	DC12	1000 ±10%	16.0	9.5	7.3	0.65
DHR4E4C101K2BB	DC15	100 ±10%	8.0	9.5	8.2	0.65
DHR4E4C151K2BB	DC15	150 ±10%	9.0	9.5	8.2	0.65
DHR4E4C221K2BB	DC15	220 ±10%	10.0	9.5	8.2	0.65
DHR4E4C331K2BB	DC15	330 ±10%	12.0	9.5	8.2	0.65
DHR4E4C471K2BB	DC15	470 ±10%	13.0	9.5	8.2	0.65
DHR4E4C681K2BB	DC15	680 ±10%	15.0	9.5	8.2	0.65
DHR4E4C102K2FB	DC15	1000 ±10%	18.0	12.7	8.2	0.8

B Characteristics

Part Number	Rated Voltage (kV)	Capacitance (pF)	Body Dia. D (mm)	Lead Spacing F (mm)	Body Thickness T (mm)	Lead Dia. ød (mm)
DHRB34A101M2BB	DC10	100 ±20%	8.0	9.5	7.0	0.65
DHRB34A151M2BB	DC10	150 ±20%	8.0	9.5	7.0	0.65
DHRB34A221M2BB	DC10	220 ±20%	9.0	9.5	7.0	0.65
DHRB34A331M2BB	DC10	330 ±20%	10.0	9.5	7.0	0.65
DHRB34A471M2BB	DC10	470 ±20%	12.0	9.5	7.0	0.65
DHRB34A681M2BB	DC10	680 ±20%	13.0	9.5	7.0	0.65
DHRB34A102M2BB	DC10	1000 ±20%	15.0	9.5	7.0	0.65
DHRB34B101M2BB	DC12	100 ±20%	8.0	9.5	7.7	0.65
DHRB34B151M2BB	DC12	150 ±20%	9.0	9.5	7.5	0.65
DHRB34B221M2BB	DC12	220 ±20%	9.0	9.5	7.5	0.65
DHRB34B331M2BB	DC12	330 ±20%	11.0	9.5	7.5	0.65
DHRB34B471M2BB	DC12	470 ±20%	12.0	9.5	7.5	0.65
DHRB34B681M2BB	DC12	680 ±20%	14.0	9.5	7.5	0.65
DHRB34B102M2BB	DC12	1000 ±20%	16.0	9.5	7.5	0.65
DHRB34C101M2BB	DC15	100 ±20%	8.0	9.5	8.5	0.65
DHRB34C151M2BB	DC15	150 ±20%	9.0	9.5	8.2	0.65
DHRB34C221M2BB	DC15	220 ±20%	10.0	9.5	8.2	0.65
DHRB34C331M2BB	DC15	330 ±20%	12.0	9.5	8.2	0.65
DHRB34C471M2BB	DC15	470 ±20%	13.0	9.5	8.2	0.65
DHRB34C681M2BB	DC15	680 ±20%	15.0	9.5	8.2	0.65
DHRB34C102M2FB	DC15	1000 ±20%	18.0	12.7	8.2	0.8

Specifications and Test Methods

No.	Item	Specifications	Test Method																				
1	Operating Temperature Range	-25 to +100°C	—																				
2	Capacitance	Within the specified tolerance	The capacitance should be measured at 20°C with 1±0.2kHz and AC5V(r.m.s.) max.																				
3	Dissipation Factor (D.F.)	<table border="1"> <tr> <td>ZM</td> <td>1.0% max.</td> </tr> <tr> <td>B</td> <td>2.5% max.</td> </tr> </table>	ZM	1.0% max.	B	2.5% max.	The dissipation factor should be measured at 20°C with 1±0.2kHz and AC5V(r.m.s.) max.																
ZM	1.0% max.																						
B	2.5% max.																						
4	Insulation Resistance (I.R.)	Between Lead Wires 10000MΩ min.	The insulation resistance should be measured with DC1000V within 60±5 sec. of charging.																				
5	Dielectric Strength	Between Lead Wires	No failure The capacitor should not be damaged when DC voltage of 150% of the rated voltage is applied between the lead wires for 60±5 sec. in insulating liquid or gas. (Charge/Discharge current≤50mA)																				
		Body Insulation	No failure The capacitor is placed in the container with metal balls of diameter 1mm so that each lead wire, short circuited, is kept approximately 2mm off the metal balls as shown in the figure at right, and DC voltage of 3kV is applied for 10 sec. between capacitor lead wires and metal balls. (Charge/Discharge current≤50mA)																				
6	Temperature Characteristics	Temp. Char.	Temp. Coefficient or Max. Cap. Change																				
		<table border="1"> <tr> <td>ZM</td> <td>-4700±1000ppm/°C</td> </tr> <tr> <td>B</td> <td>±10%</td> </tr> </table>	ZM	-4700±1000ppm/°C	B	±10%	<table border="1"> <tr> <th>Step Char.</th> <th>1</th> <th>2</th> <th>3</th> <th>4</th> <th>5</th> </tr> <tr> <td>ZM</td> <td>—</td> <td>—</td> <td>20±2°C</td> <td>85±2°C</td> <td>20±2°C</td> </tr> <tr> <td>B</td> <td>20±2°C</td> <td>-25±3°C</td> <td>20±2°C</td> <td>85±2°C</td> <td>20±2°C</td> </tr> </table>	Step Char.	1	2	3	4	5	ZM	—	—	20±2°C	85±2°C	20±2°C	B	20±2°C	-25±3°C	20±2°C
ZM	-4700±1000ppm/°C																						
B	±10%																						
Step Char.	1	2	3	4	5																		
ZM	—	—	20±2°C	85±2°C	20±2°C																		
B	20±2°C	-25±3°C	20±2°C	85±2°C	20±2°C																		
7	Soldering Effect (Non-Preheat)	Appearance	No marked defect																				
		Capacitance Change	Within ±10%																				
		Dielectric Strength (Between Lead Wires)	No failure																				
8	Soldering Effect (On-Preheat)	Appearance	No marked defect																				
		Capacitance Change	Within ±10%																				
		Dielectric Strength (Between Lead Wires)	No failure																				
9	Humidity (Under Steady State)	Appearance	No marked defect																				
		Capacitance Change	Within ±10%																				
		D.F.	<table border="1"> <tr> <td>ZM</td> <td>1.5% max.</td> </tr> <tr> <td>B</td> <td>4.0% max.</td> </tr> </table>	ZM	1.5% max.	B	4.0% max.																
		ZM	1.5% max.																				
		B	4.0% max.																				
I.R.	5000MΩ min.																						
Dielectric Strength (Between Lead Wires)	No failure																						

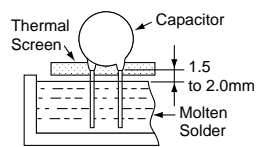
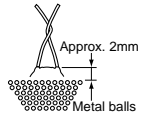

(Note) Tests for Dielectric Strength (Between Lead Wires), Charge Discharge Test, Humidity, Temperature Cycle and Life should be performed with specimens having molded resin (MR1023C: made by Murata) extending over 3mm on all the surface.

* "room condition" Temperature: 15 to 35°C, Relative humidity: 45 to 75%, Atmospheric pressure: 86 to 106kPa

Continued on the following page.

Specifications and Test Methods

Continued from the preceding page.

No.	Item	Specifications	Test Method				
10	Life	Appearance	No marked defect				
		Capacitance Change	Within ±10%				
		D.F.	<table border="1"> <tr> <td>ZM</td> <td>1.5% max.</td> </tr> <tr> <td>B</td> <td>4.0% max.</td> </tr> </table>	ZM	1.5% max.	B	4.0% max.
		ZM	1.5% max.				
		B	4.0% max.				
I.R.	5000MΩ min.						
Dielectric Strength (Between Lead Wires)	No failure						
11	Charge Discharge Test	Appearance	No marked defect				
		Capacitance Change	Within ±10%				
		D.F.	<table border="1"> <tr> <td>ZM</td> <td>1.5% max.</td> </tr> <tr> <td>B</td> <td>4.0% max.</td> </tr> </table>	ZM	1.5% max.	B	4.0% max.
		ZM	1.5% max.				
		B	4.0% max.				
I.R.	5000MΩ min.						
Dielectric Strength (Between Lead Wires)	No failure						
12	Temperature Cycle	Appearance	No marked defect				
		Capacitance Change	Within ±10%				
		D.F.	<table border="1"> <tr> <td>ZM</td> <td>1.5% max.</td> </tr> <tr> <td>B</td> <td>4.0% max.</td> </tr> </table>	ZM	1.5% max.	B	4.0% max.
		ZM	1.5% max.				
		B	4.0% max.				
I.R.	5000MΩ min.						
Dielectric Strength (Between Lead Wires)	No failure						
13	Strength of Lead	Pull	Lead wire should not be cut off. Capacitor should not be broken.				
		Bending	Each lead wire should be subjected to 5N of weight and bent 90° at the point of egress, in one direction, then returned to its original position and bent 90° in the opposite direction at the rate of one bend in 2 to 3 sec.				
14	Solderability of Leads	Lead wire should be soldered with uniform coating on the axial direction over $\frac{3}{4}$ of the circumferential direction.	The lead wire of a capacitor should be dipped into a 25% ethanol solution of rosin and then into molten solder for 2±0.5 sec. In both cases the depth of dipping is up to about 1.5 to 2.0mm from the root of lead wires. Temp. of solder: Lead Free Solder (Sn-3Ag-0.5Cu) 245±5°C H63 Eutectic Solder 235±5°C				

Apply a DC voltage of 125% of the rated voltage for 1000⁺⁴⁸₀ hrs. in silicon oil at 100±2°C.
 Post-treatment: Capacitor should be stored for 24±2 hrs. at room condition*.
 (Charge/Discharge current ≤50mA)

Charge discharge test should be measured in the following test circuit and cycle.
 Applied voltage: Rated voltage
 Cycle time: 20000 cycle
 Post-treatment: Capacitor should be stored for 4 hrs. at room condition*.

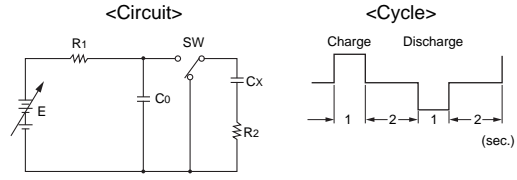

Cx: specimen
 R1: circuit protective resistor (300kΩ)
 C0: supplied energy for Cx. C0=10Cx
 R2: current limiting resistor (E/10Ω)
 E: direct-current voltage source

Temperature cycle should be measured in the following test.
 Cycle time: 5 cycle
 Post-treatment: Capacitor should be stored for 4 hrs. at room condition*.

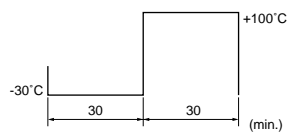

(Note) Tests for Dielectric Strength (Between Lead Wires), Charge Discharge Test, Humidity, Temperature Cycle and Life should be performed with specimens having molded resin (MR1023C: made by Murata) extending over 3mm on all the surface.

* "room condition" Temperature: 15 to 35°C, Relative humidity: 45 to 75%, Atmospheric pressure: 86 to 106kPa

Typical Characteristics Data/Packaging

■ Cap. - Temp. Char.

ZM Characteristics

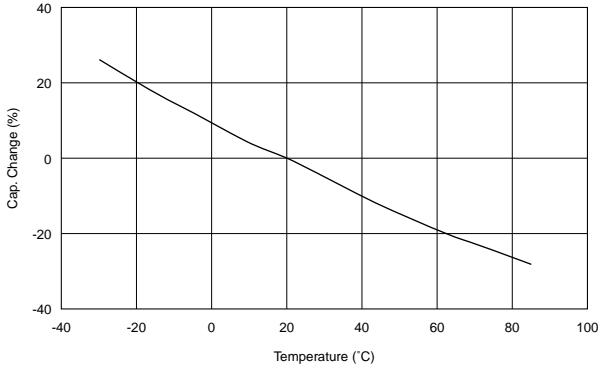

B Characteristics

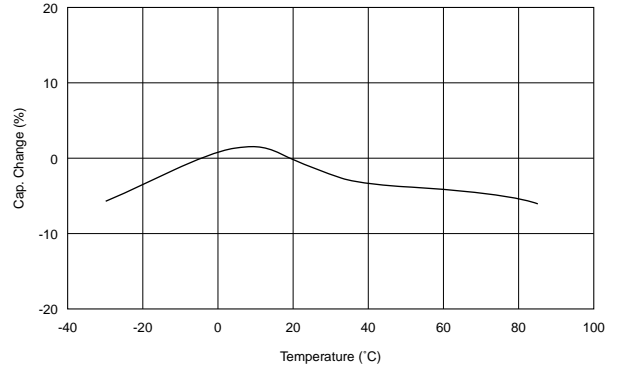

■ Cap. - DC Bias Char.

ZM Characteristics

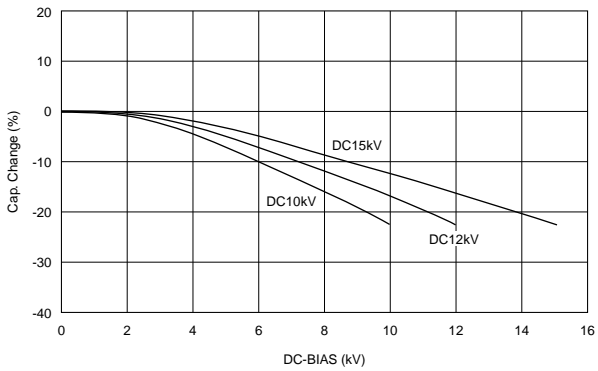

B Characteristics

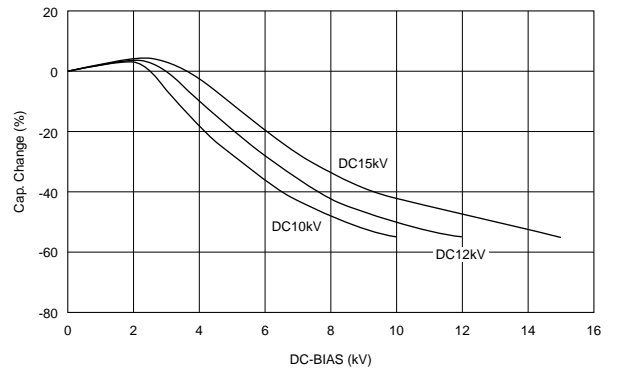

■ Packaging Styles



■ Example

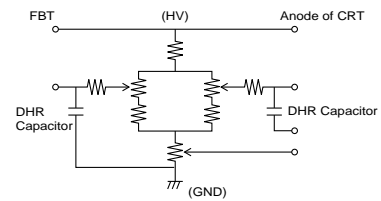

Minimum Quantity (Order in Sets Only)	200 (pcs.)
Minimum Order Quantity	200 (pcs.)

- "Minimum Quantity" means the number of units of each delivery or order. The quantity should be an integral multiple of the "minimum quantity". (Please note that the actual delivery quantity in a package may change sometimes.)

DHR Series ⚠ Caution/Notice

■ ⚠ Caution (Rating)

1. Operating Voltage

When DC-rated capacitors are to be used in AC or ripple current circuits, be sure to maintain the V_{p-p} value of the applied voltage or the V_{0-p} which contains DC bias within the rated voltage range.

When the voltage is applied to the circuit, starting or stopping may generate irregular voltage for a transit period because of resonance or switching. Be sure to use a capacitor with a rated voltage range that includes these irregular voltages.

Voltage	DC Voltage	DC+AC Voltage	AC Voltage	Pulse Voltage (1)	Pulse Voltage (2)
Positional Measurement					

2. Operating Temperature and Self-generated Heat

Keep the surface temperature of a capacitor below the upper limit of its rated operating temperature range. Be sure to take into account the heat generated by the capacitor itself. When the capacitor is used in a high-frequency current, pulse current or similar current, it may self-generate heat due to dielectric loss. The applied voltage load should be such that the capacitor's self-generated heat is within 10°C at an atmosphere temperature of 25°C . When measuring, use a thermocouple of small thermal capacity-K of $\phi 0.1\text{mm}$ in conditions where the capacitor is not affected by radiant heat from other components or surrounding ambient fluctuations. Excessive heat may lead to deterioration of the capacitor's characteristics and reliability. (Never attempt to perform measurement with the cooling fan running. Otherwise, accurate measurement cannot be ensured.)

FAILURE TO FOLLOW THE ABOVE CAUTIONS MAY RESULT, WORST CASE, IN A SHORT CIRCUIT AND CAUSE FUMING OR PARTIAL DISPERSION WHEN THE PRODUCT IS USED.

■ ⚠ Caution (Storage and Operation Condition)

Operating and Storage Environment

The insulating coating of capacitors does not form a perfect seal; therefore, do not use or store capacitors in a corrosive atmosphere, especially where chloride gas, sulfide gas, acid, alkali, salt or the like are present. And avoid exposure to moisture.

The capacitor is designed to be used in insulating media, such as epoxy resin, silicone oil, etc.

There must be 3mm or more of insulating media for each direction of the capacitor.

Before cleaning, bonding, or molding this product, verify that these processes do not affect product quality by testing the performance of a cleaned, bonded or molded product in the intended equipment. Store the capacitors where the temperature and relative humidity do not exceed -10 to 40 degrees centigrade and 15 to 85%. Use capacitors within 6 months after delivered.

FAILURE TO FOLLOW THE ABOVE CAUTIONS MAY RESULT, WORST CASE, IN A SHORT CIRCUIT AND CAUSE FUMING OR PARTIAL DISPERSION WHEN THE PRODUCT IS USED.

■ ⚠ Caution (Soldering and Mounting)

1. Vibration and Impact

Do not expose a capacitor or its leads to excessive shock or vibration during use.

2. Soldering

When soldering this product to a PCB/PWB, do not exceed the solder heat resistance specification of the capacitor. Subjecting this product to excessive heating could melt the internal junction solder and may result in thermal shocks that can crack the ceramic element.

When soldering capacitor with a soldering iron, it should be performed in following conditions.

Temperature of iron-tip: 400 degrees C. max.

Soldering iron wattage : 50W max.

Soldering time : 3.5 sec. max.

FAILURE TO FOLLOW THE ABOVE CAUTIONS MAY RESULT, WORST CASE, IN A SHORT CIRCUIT AND CAUSE FUMING OR PARTIAL DISPERSION WHEN THE PRODUCT IS USED.

■ ⚠ Caution (Handling)

Vibration and Impact

Do not expose a capacitor or its leads to excessive shock or vibration during use.

FAILURE TO FOLLOW THE ABOVE CAUTIONS MAY RESULT, WORST CASE, IN A SHORT CIRCUIT AND CAUSE FUMING OR PARTIAL DISPERSION WHEN THE PRODUCT IS USED.

■ Notice (Soldering and Mounting)

Cleaning (ultrasonic cleaning)

To perform ultrasonic cleaning, observe the following conditions.

Rinse bath capacity: Output of 20 watts per liter or less.

Rinsing time: 5 min. maximum.

Do not vibrate the PCB/PWB directly.

Excessive ultrasonic cleaning may lead to fatigue destruction of the lead wires.

■ Notice (Rating)

Capacitance Change of Capacitor

1. Class 1 Capacitors

Capacitance might change a little depending on the surrounding temperature or an applied voltage.

Please contact us if you intend to use this product in a strict time constant circuit.

2. Class 2 and 3 Capacitors

Class 2 and 3 capacitors with temperature characteristics B, E and F have an aging characteristic, whereby the capacitor continually decreases its capacitance slightly if the capacitor is left on for a long time. Moreover, capacitance might change greatly depending on the surrounding temperature or an applied voltage.

So, it is not likely to be suitable for use in a time constant circuit. Please contact us if you need detailed information.

High Voltage Ceramic Capacitors DC10-40kV



Mold Type DHS N4700 Series (DC10-40kV)

2

Murata's high voltage ceramic capacitors, DHS N4700 series, are designed to meet the stringent requirements of high voltage applications. These capacitors are especially appropriate for applications which require a low dissipation factor and a small voltage coefficient.

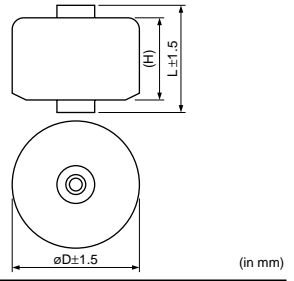

DC Rated Voltage (kV)	Depth of Tapped Holes (mm)
10, 15	4
20, 30	6
40	8

■ Features

1. Epoxy resin encapsulated
2. Small size
3. Low dissipation factor and low heating value
4. Linear temperature characteristic
5. Low DC, AC-voltage coefficient

■ Applications

- Gas laser
- DC HV power supplies
- Lightning arresters, voltage distribution systems
- Electron microscopes, synchroscopes
- Electrostatic coating machines

Part Number	Capacitance (pF)	Capacitance Tolerance (%)	DC Rated Voltage (kV)	Dimensions (mm)			Terminal Type (Screw Thread Type)			
				D	L	H				
DHS4E4A561KC2B	560	±10	10	20	16	12	ISO M4, P0.7 (Metric Screw Thread)			
DHS4E4A122KH2B	1200			30						
DHS4E4A282KL2B	2800			38						
DHS4E4A502KR2B	5000			52						
DHS4E4A802KT2B	8000			60						
DHS4E4A561MCXB	560	±20		10			20	16	12	No.8-32, NC-2B (Inch Screw Thread)
DHS4E4A122MHXB	1200						30			
DHS4E4A282MLXB	2800						38			
DHS4E4A502MRXB	5000						52			
DHS4E4A802MTXB	8000						60			
DHS4E4C371KC2B	370	±10	15		20	18	14			ISO M4, P0.7 (Metric Screw Thread)
DHS4E4C112KH2B	1100				30					
DHS4E4C192KL2B	1900				38					
DHS4E4C342KR2B	3400				52					
DHS4E4C532KT2B	5300				60					
DHS4E4C371MCXB	370	±20		15	20			18	14	No.8-32, NC-2B (Inch Screw Thread)
DHS4E4C112MHXB	1100				30					
DHS4E4C192MLXB	1900				38					
DHS4E4C342MRXB	3400				52					
DHS4E4C532MTXB	5300				60					

Continued on the following page.

Continued from the preceding page.

Part Number	Capacitance (pF)	Capacitance Tolerance (%)	DC Rated Voltage (kV)	Dimensions (mm)			Terminal Type (Screw Thread Type)	
				D	L	H		
DHS4E4D281KC2B	280	±10	20	20	24	20	ISO M4, P0.7 (Metric Screw Thread)	
DHS4E4D881KH2B	880			30				
DHS4E4D142KL2B	1400			38				
DHS4E4D252KR2B	2500			52				
DHS4E4D402KT2B	4000			60				
DHS4E4D281MCXB	280	±20		20	24	20		No.8-32, NC-2B (Inch Screw Thread)
DHS4E4D881MHXB	880			30				
DHS4E4D142MLXB	1400			38				
DHS4E4D252MRXB	2500			52				
DHS4E4D402MTXB	4000			60				
DHS4E4F191KC2B	190	±10	30	20	28	24	ISO M4, P0.7 (Metric Screw Thread)	
DHS4E4F591KH2B	590			30				
DHS4E4F941KL2B	940			38				
DHS4E4F172KR2B	1700			52				
DHS4E4F272KT2B	2700			60				
DHS4E4F191MCXB	190	±20		20	28	24		No.8-32, NC-2B (Inch Screw Thread)
DHS4E4F591MHXB	590			30				
DHS4E4F941MLXB	940			38				
DHS4E4F172MRXB	1700			52				
DHS4E4F272MTXB	2700			60				
DHS4E4G141KC2B	140	±10	40	20	36	32	ISO M4, P0.7 (Metric Screw Thread)	
DHS4E4G441KH2B	440			30				
DHS4E4G701KL2B	700			38				
DHS4E4G132KR2B	1300			52				
DHS4E4G202KT2B	2000			60				
DHS4E4G141MCXB	140	±20		20	36	32		No.8-32, NC-2B (Inch Screw Thread)
DHS4E4G441MHXB	440			30				
DHS4E4G701MLXB	700			38				
DHS4E4G132MRXB	1300			52				
DHS4E4G202MTXB	2000			60				

2

Specifications and Test Methods/Typical Characteristics Data

2

No.	Item	Specifications	Test Method												
1	Operating Temperature Range	-20 to +85°C	—												
2	Capacitance	Within the specified tolerance	The capacitance should be measured at 20°C with 1±0.1kHz and AC1 to 5V(r.m.s.).												
3	Temperature Characteristics	Temperature coefficient -4700±1000ppm/°C (Temp. range: +20 to +85°C)	The capacitance measurement should be made at each step specified in table. Capacitance change from the value of step 3 should not exceed the limit specified. <table border="1" style="margin: 5px auto; border-collapse: collapse;"> <thead> <tr> <th>Step</th> <th>1</th> <th>2</th> <th>3</th> <th>4</th> <th>5</th> </tr> </thead> <tbody> <tr> <td>Temp. (°C)</td> <td style="text-align: center;">—</td> <td style="text-align: center;">—</td> <td style="text-align: center;">20±2</td> <td style="text-align: center;">85±2</td> <td style="text-align: center;">20±2</td> </tr> </tbody> </table>	Step	1	2	3	4	5	Temp. (°C)	—	—	20±2	85±2	20±2
Step	1	2	3	4	5										
Temp. (°C)	—	—	20±2	85±2	20±2										
4	Dissipation Factor (D.F.)	0.3% max.	The dissipation factor should be measured at 20°C with 1±0.1kHz and AC1 to 5V(r.m.s.).												
5	Dielectric Strength	Between Terminals No failure	The capacitor should not be damaged when DC voltage of 150% of the rated voltage is applied between the terminals for 60±5 sec. in insulating liquid or gas. (Charge/Discharge current ≤ 50mA)												
6	Insulation Resistance (I.R.)	10000MΩ min.	The insulation resistance should be measured with DC1000V within 60±5 sec. of charging.												
7	Strength of Terminal	Torque Strength Capacitor should not be broken.	When mounting the capacitor on equipment, be sure to mount them within the torque strength values shown in the table below. <table border="1" style="margin: 5px auto; border-collapse: collapse;"> <thead> <tr> <th>Terminal Type</th> <th>Torque (N·m)</th> </tr> </thead> <tbody> <tr> <td>ISO M4, No.8-32</td> <td style="text-align: center;">1.5</td> </tr> </tbody> </table>	Terminal Type	Torque (N·m)	ISO M4, No.8-32	1.5								
Terminal Type	Torque (N·m)														
ISO M4, No.8-32	1.5														
8	Life	Appearance	Apply a DC voltage of 125% of the rated voltage for 100+24/-0 hrs. in silicon oil at 85±2°C. Post-treatment: Capacitor should be stored for 24 hrs. at room condition*. (Charge/Discharge current ≤ 50mA)												
		Capacitance Change		Within ±5%											
		D.F.		1.0% max.											
		I.R.		1000MΩ min.											
9	Humidity (Under Steady State)	Appearance	Set the capacitor for 100+24/-0 hrs. at 40±2°C in 90 to 95% relative humidity. Post-treatment: Capacitor should be stored for 24 hrs. at room condition*.												
		Capacitance Change		Within ±5%											
		D.F.		1.0% max.											
		I.R.		1000MΩ min.											

* "room condition" Temperature: 15 to 35°C, Relative humidity: 45 to 75%, Atmospheric pressure: 86 to 106kPa

■ Temperature Characteristics

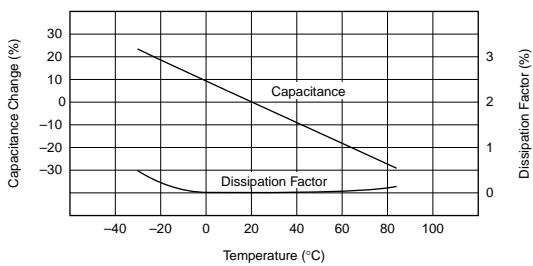

■ Typical Voltage Coefficient

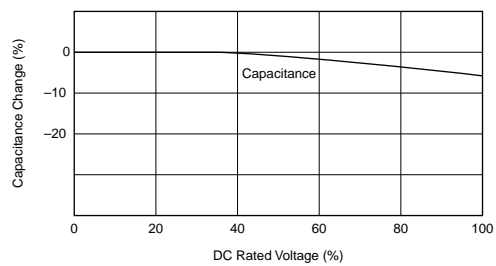

■ Frequency Characteristics

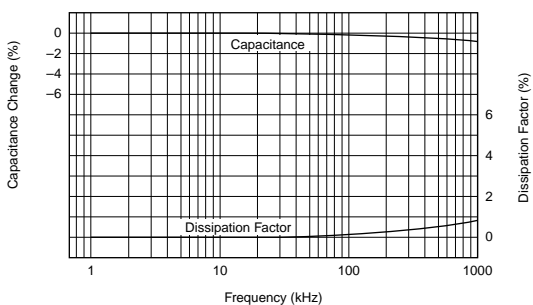

High Voltage Ceramic Capacitors DC10-40kV



Mold Type DHS Z5V Series (DC20-40kV)

■ Features

1. Epoxy resin encapsulated
2. Small size
3. Highly reliable internal construction
4. Wide selection of values
5. Up to DC40kV working voltage

■ Applications

- Electrostatic coating machines
- Electron microscopes, synchroscopes
- CRT power supplies
- Lightning arrester voltage distribution systems
- DC HV power supplies

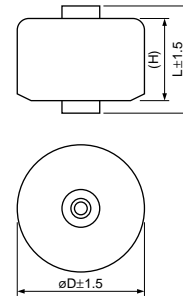

(in mm)

DC Rated Voltage (kV)	Depth of Tapped Holes (mm)
20, 30, 40	4

Part Number	Capacitance (pF)	Capacitance Tolerance (%)	DC Rated Voltage (kV)	Dimensions (mm)			Terminal Type (Screw Thread Type)
				D	L	H	
DHSF44D601ZD2B	600	+80, -20	20	24	26	24	ISO M4, P0.7 (Metric Screw Thread)
DHSF44D102ZH2B	1000			30			
DHSF44D242ZN2B	2400			43			
DHSF44D332ZR2B	3300			52			
DHSF44D482ZT2B	4800			60			
DHSF44D601ZDXB	600			24			
DHSF44D102ZHXB	1000			30			
DHSF44D242ZNXB	2400			43			
DHSF44D332ZRXB	3300			52			
DHSF44D482ZTXB	4800			60			
DHSF44F461ZD2B	460		30	24	34	32	ISO M4, P0.7 (Metric Screw Thread)
DHSF44F781ZH2B	780			30			
DHSF44F182ZN2B	1800			43			
DHSF44F252ZR2B	2500			52			
DHSF44F362ZT2B	3600			60			
DHSF44F461ZDXB	460			24			
DHSF44F781ZHXB	780			30			
DHSF44F182ZNXB	1800			43			
DHSF44F252ZRXB	2500			52			
DHSF44F362ZTXB	3600			60			
DHSF44G341ZD2B	340	40	24	41	39	ISO M4, P0.7 (Metric Screw Thread)	
DHSF44G571ZH2B	570		30				
DHSF44G132ZN2B	1300		43				
DHSF44G192ZR2B	1900		52				
DHSF44G272ZT2B	2700		60				
DHSF44G341ZDXB	340		24				
DHSF44G571ZHXB	570		30				
DHSF44G132ZNXB	1300		43				
DHSF44G192ZRXB	1900		52				
DHSF44G272ZTXB	2700		60				

3

Specifications and Test Methods

No.	Item		Specifications	Test Method												
1	Operating Temperature Range		-20 to +85°C	—												
2	Capacitance		Within the specified tolerance	The capacitance should be measured at 25°C with 1±0.1kHz and AC1 to 5V(r.m.s.).												
3	Temperature Characteristics		Capacitance change Within +22/-82% (Temp. range: +10 to +85°C)	The capacitance measurement should be made at each step specified in table. Capacitance change from the value of step 3 should not exceed the limit specified. <table border="1" style="margin-left: auto; margin-right: auto;"> <thead> <tr> <th>Step</th> <th>1</th> <th>2</th> <th>3</th> <th>4</th> <th>5</th> </tr> </thead> <tbody> <tr> <td>Temp. (°C)</td> <td>25±2</td> <td>-20±3</td> <td>25±2</td> <td>85±2</td> <td>25±2</td> </tr> </tbody> </table>	Step	1	2	3	4	5	Temp. (°C)	25±2	-20±3	25±2	85±2	25±2
Step	1	2	3	4	5											
Temp. (°C)	25±2	-20±3	25±2	85±2	25±2											
4	Dissipation Factor (D.F.)		1.5% max.	The dissipation factor should be measured at 25°C with 1±0.1kHz and AC1 to 5V(r.m.s.).												
5	Dielectric Strength	Between Terminals	No failure	The capacitor should not be damaged when DC voltage of 150% of the rated voltage is applied between the terminals for 60±5 sec. in insulating liquid or gas. (Charge/Discharge current ≤ 50mA)												
6	Insulation Resistance (I.R.)		10000MΩ min.	The insulation resistance should be measured with DC1000V within 60±5 sec. of charging.												
7	Strength of Terminal	Torque Strength	Capacitor should not be broken.	When mounting the capacitor on equipment, be sure to mount them within the torque strength values shown in the table below. <table border="1" style="margin-left: auto; margin-right: auto;"> <thead> <tr> <th>Terminal Type</th> <th>Torque (N·m)</th> </tr> </thead> <tbody> <tr> <td>ISO M4, No.8-32</td> <td>1.5</td> </tr> </tbody> </table>	Terminal Type	Torque (N·m)	ISO M4, No.8-32	1.5								
Terminal Type	Torque (N·m)															
ISO M4, No.8-32	1.5															
8	Life	Appearance	No marked defect	Apply a DC voltage of 125% of the rated voltage for 100+24/-0 hrs. in silicon oil at 85±2°C. Post-treatment: Capacitor should be stored for 24 hrs. at room condition*. (Charge/Discharge current ≤ 50mA)												
		Capacitance Change	Within ±20%													
		D.F.	5.0% max.													
		I.R.	1000MΩ min.													
9	Humidity (Under Steady State)	Appearance	No marked defect	Set the capacitor for 100+24/-0 hrs. at 40±2°C in 90 to 95% relative humidity. Post-treatment: Capacitor should be stored for 24 hrs. at room condition*.												
		Capacitance Change	Within ±20%													
		D.F.	5.0% max.													
		I.R.	1000MΩ min.													

* "room condition" Temperature: 15 to 35°C, Relative humidity: 45 to 75%, Atmospheric pressure: 86 to 106kPa

Typical Characteristics Data

■ Dissipation Factor and Capacitance - Temperature

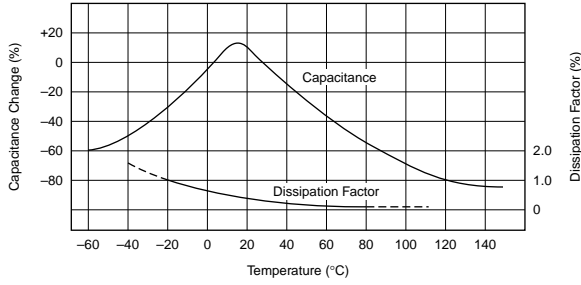

■ Life

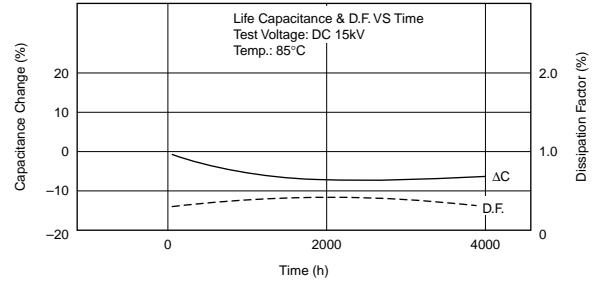

■ Dissipation Factor and Capacitance - Frequency

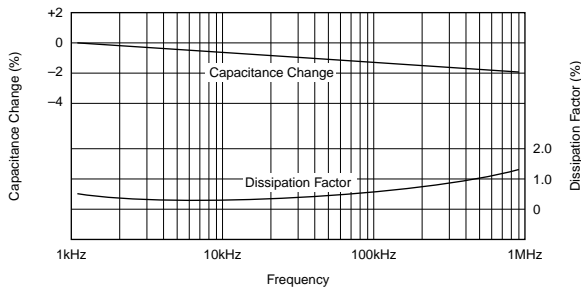

■ Humidity

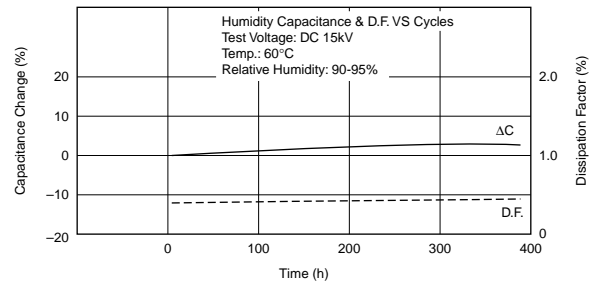

■ Typical Voltage Coefficient

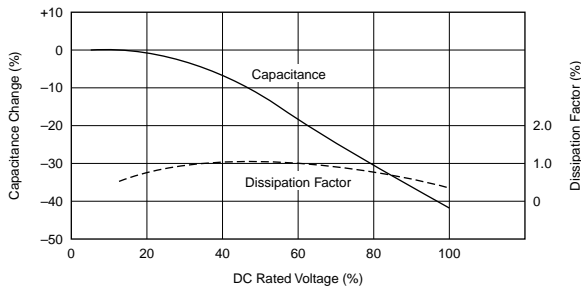

DHS Series ⚠ Caution/Notice

⚠ Caution

1. Operating Voltage

When DC-rated capacitors are to be used in AC or ripple current circuits, be sure to maintain the V_{p-p} value of the applied voltage or the V_{o-p} which contains DC bias within the rated voltage range. When the voltage is applied to the circuit, starting or stopping may generate irregular voltage for a transit period because of resonance or switching. Be sure to use a capacitor with a rated voltage range that includes these irregular voltages.

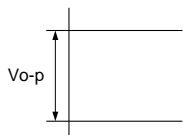
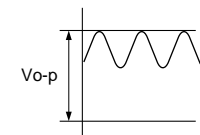
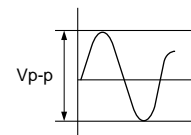
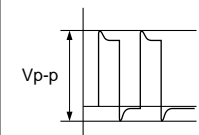
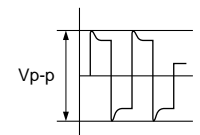
Voltage	DC Voltage	DC+AC Voltage	AC Voltage	Pulse Voltage (1)	Pulse Voltage (2)
Positional Measurement					

2. Operating Temperature and Self-generated Heat

Keep the surface temperature of a capacitor below the upper limit of its rated operating temperature range. Be sure to take into account the heat generated by the capacitor itself.

When the capacitor is used in a high-frequency current, pulse current or similar current, it may self-generate heat due to dielectric loss. The applied voltage load should be such that the capacitor's self-generated heat is within 10°C at an atmosphere temperature of 25°C.

When measuring, use a thermocouple of small thermal capacity-K of $\varnothing 0.1\text{mm}$ in conditions where the capacitor is not affected by radiant heat from other components or surrounding ambient fluctuations.

Excessive heat may lead to deterioration of the capacitor's characteristics and reliability. (Never attempt to perform measurement with the cooling fan running. Otherwise, accurate measurement cannot be ensured.)

3. Installation

Installation torque should not exceed the torque strength values in "Specifications and Test Methods".

Do not use a screw with a thread depth greater than specified.

Avoid installation in which any bending torque is applied to the capacitor terminal.

Do not rework or resolder the terminal.

4. Operating and Storage Environment

The insulating coating of capacitors does not form a perfect seal; therefore, do not use or store capacitors in a corrosive atmosphere, especially where chloride gas, sulfide gas, acid, alkali, salt or the like are present. And avoid exposure to moisture.

Before cleaning, bonding, or molding this product, verify that these processes do not affect product quality by testing the performance of a cleaned, bonded or molded product in the intended equipment. Store the capacitors where the temperature and relative humidity do not exceed -10 to 40 degrees centigrade and 15 to 85%. Use capacitors within 6 months after delivered.

5. Vibration and Impact

Do not expose a capacitor to excessive shock or vibration during use.

FAILURE TO FOLLOW THE ABOVE CAUTIONS MAY RESULT, WORST CASE, IN A SHORT CIRCUIT AND CAUSE FUMING OR PARTIAL DISPERSION WHEN THE PRODUCT IS USED.

■ Notice

Capacitance Change of Capacitor

1. Class 1 Capacitors

Capacitance might change a little depending on the surrounding temperature or an applied voltage.

Please contact us if you intend to use this product in a strict time constant circuit.

2. Class 2 and 3 Capacitors

Class 2 and 3 capacitors with temperature characteristics B, E and F have an aging characteristic, whereby the capacitor continually decreases its capacitance slightly if the capacitor is left on for a long time. Moreover, capacitance might change greatly depending on the surrounding temperature or an applied voltage.

So, it is not likely to be suitable for use in a time constant circuit. Please contact us if you need detailed information.

ISO9000 Certifications

Manufacturing plants which produce the products in this catalog have obtained the ISO9000 quality system certificate.

Plant	Applied Standard
Izumo Murata Manufacturing Co., Ltd.	ISO9001
Murata Electronics (Thailand), Ltd.	ISO9001

△Note:

1. Export Control

〈For customers outside Japan〉

No muRata products should be used or sold, through any channels, for use in the design, development, production, utilization, maintenance or operation of, or otherwise contribution to (1) any weapons (Weapons of Mass Destruction (nuclear, chemical or biological weapons or missiles) or conventional weapons) or (2) goods or systems specially designed or intended for military end-use or utilization by military end-users.

〈For customers in Japan〉

For products which are controlled items subject to the "Foreign Exchange and Foreign Trade Law" of Japan, the export license specified by the law is required for export.

2. Please contact our sales representatives or product engineers before using the products in this catalog for the applications listed below, which require especially high reliability for the prevention of defects which might directly damage a third party's life, body or property, or when one of our products is intended for use in applications other than those specified in this catalog.

- | | |
|-----------------------------|--|
| ① Aircraft equipment | ② Aerospace equipment |
| ③ Undersea equipment | ④ Power plant equipment |
| ⑤ Medical equipment | ⑥ Transportation equipment (vehicles, trains, ships, etc.) |
| ⑦ Traffic signal equipment | ⑧ Disaster prevention / crime prevention equipment |
| ⑨ Data-processing equipment | ⑩ Application of similar complexity and/or reliability requirements to the applications listed above |

3. Product specifications in this catalog are as of May 2007. They are subject to change or our products in it may be discontinued without advance notice. Please check with our sales representatives or product engineers before ordering. If there are any questions, please contact our sales representatives or product engineers.

4. Please read rating and △CAUTION (for storage, operating, rating, soldering, mounting and handling) in this catalog to prevent smoking and/or burning, etc.

5. This catalog has only typical specifications because there is no space for detailed specifications. Therefore, please approve our product specifications or transact the approval sheet for product specifications before ordering.

6. Please note that unless otherwise specified, we shall assume no responsibility whatsoever for any conflict or dispute that may occur in connection with the effect of our and/or a third party's intellectual property rights and other related rights in consideration of your use of our products and/or information described or contained in our catalogs. In this connection, no representation shall be made to the effect that any third parties are authorized to use the rights mentioned above under licenses without our consent.

7. No ozone depleting substances (ODS) under the Montreal Protocol are used in our manufacturing process.