

RAFIX 22 QR, illuminated pushbutton, protruding front ring, round collar, momentary contact function, frontring metallic silver, bezel yellow



fields of application

- › Measurement-control-regulation
- › Electrical engineering
- › Mechanical and system engineering
- › Vehicle construction

special features

- › Transparent panels, illuminable
- › Lettering with inserts possible
- › Firmly moulded collar seal, cannot twist or be lost during installation.
- › 1-person mounting: the element is clamped in the mounting hole by the seal and can then bescrewed in from behind.
- › Robust - also suitable for operation with gloves on
- › Degree of protection: IP 65 at the front
- › Mounting diameter 22.3 mm
- › Separate switching elements required
- › Close mounting of actuators possible (min. 30 x 50 mm), as wiring is axial from behind
- › Switching elements with silver contacts (max. 400 V) or gold contacts (max. 35 V / 100 mA)
- › Connection types switching elements: cage clamp, screw connection or plug-in connection



description

RAFIX control units are modular units consisting of several parts. In the RAFIX 22 QR family, they always consist of an actuating element, coupling, and switching element, or of a light attachment, coupling, and lamp socket. For assembly, the switching elements and lamp holders are first snapped into the coupling. Then this unit is snapped onto the actuating element or the signal lamp. To release, a bayonet lever must be actuated.

Actuating elements (such as pushbuttons or emergency stop actuators) have the specified tactility and function only when assembled with the appropriate switching elements. For illuminated actuators and illuminated attachments, please use a lamp socket / LED element as the middle element in the coupling.

For RAFIX 22 QR actuating elements, you can choose between two collar shapes: round and square. The mounting diameter is 22.3 mm according to the standard. The anti-rotation lug can be easily removed with a screwdriver if necessary.

Additional information according to UL certificate:

➤ These devices should be mounted in an overall enclosure with sufficient stability and with the specified clearances.

technical data

➤ general

Bezel color	yellow
Property of bezel / mushroom	transparent
Front ring color	metallic silver
Collar shape	round
Operating temperature, min.	-25 °C
Operating temperature, max.	70 °C
Storage temperature, min.	-40 °C
Storage temperature, max.	80 °C
illuminated	Yes
Packaging	Box
Packaging unit	10 pcs.
net weight	14.2 g
Operating life	1,000,000 cycles
B10	1,300,000 cycles
Degree of protection, front side, according to DIN EN 60529	IP65
Environment resistance	IEC 60068-2-14 IEC 60068-2-30 IEC 60068-2-33 IEC 60068-2-78
MOQ order	10 pcs.
RoHS compliant	Yes
REACH compliant	Yes

direct links

➤ [RAFI eCatalog](#)

> mounting diameters

Outside dimension, length	29.8 mm
Outside dimension, width	29.8 mm
Outside dimension, height	35.5 mm
Mounting hole	22.3 mm
Mounting depth	56.4 mm
Installation height	12.6 mm
Grid, min.	50 x 30 mm
Collar dimension	ø 29,8 mm

> mechanical data

Actuation function	momentary contact function
Operating force, max.	100 N
Operating travel, max.	4 mm
Fixing	Threaded ring
Threaded ring torque, max.	1.2 Nm

drawings

System drawing

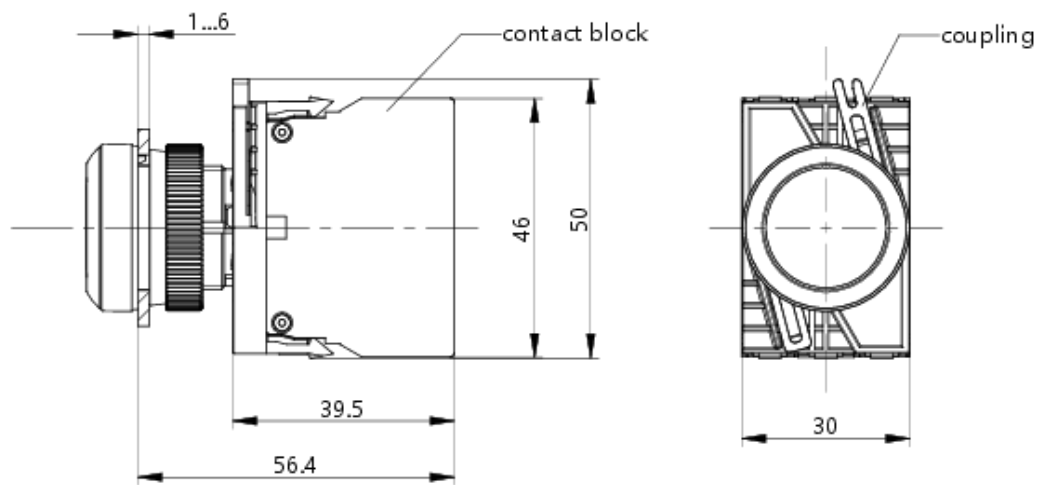

front panel drawing

