

# Xinger®

## Directional Couplers 30 dB

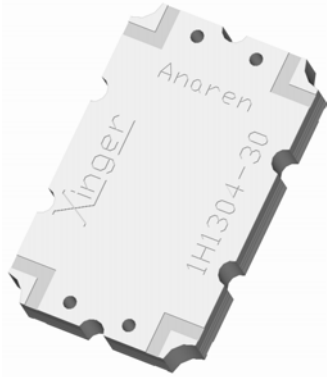

### Description

The 1H1304-30 is a low profile 30dB directional coupler in an easy to use surface mount package covering the AMPS and GSM bands. The 1H1304-30 is ideal for power and frequency detection as well as VSWR monitoring and can be used in most high power designs. Parts have been subjected to rigorous qualification testing and units are 100% tested. They are manufactured using materials with x and y thermal expansion coefficients compatible with common substrates such as FR4, G-10 and polyamide.

### Features:

- 800 - 1000 MHz
- Low loss
- High Directivity
- Surface Mountable
- Tape And Reel
- Convenient Package
- 100% Tested

### ELECTRICAL SPECIFICATIONS\*\*

Frequency	Mean Coupling	Insertion Loss	VSWR	Freq. Sensitivity
MHz	dB	dB Max	Max:1	dB Max
869 - 894	30 ± 2.5	0.25	1.20	±0.10
800 - 1000	30 ± 2.5	0.25	1.27	±0.30
Directivity	Power Handling	ΘJC	Operating Temp.	
dB Min	Watts	°C / Watt	°C	
18	150	9.6	-55 to +85	
18	150	9.6	-55 to +85	

\*\*Specification based on performance of unit properly installed on microstrip printed circuit boards with 50 Ω nominal impedance. Specifications subject to change without notice.

### Outline Drawing

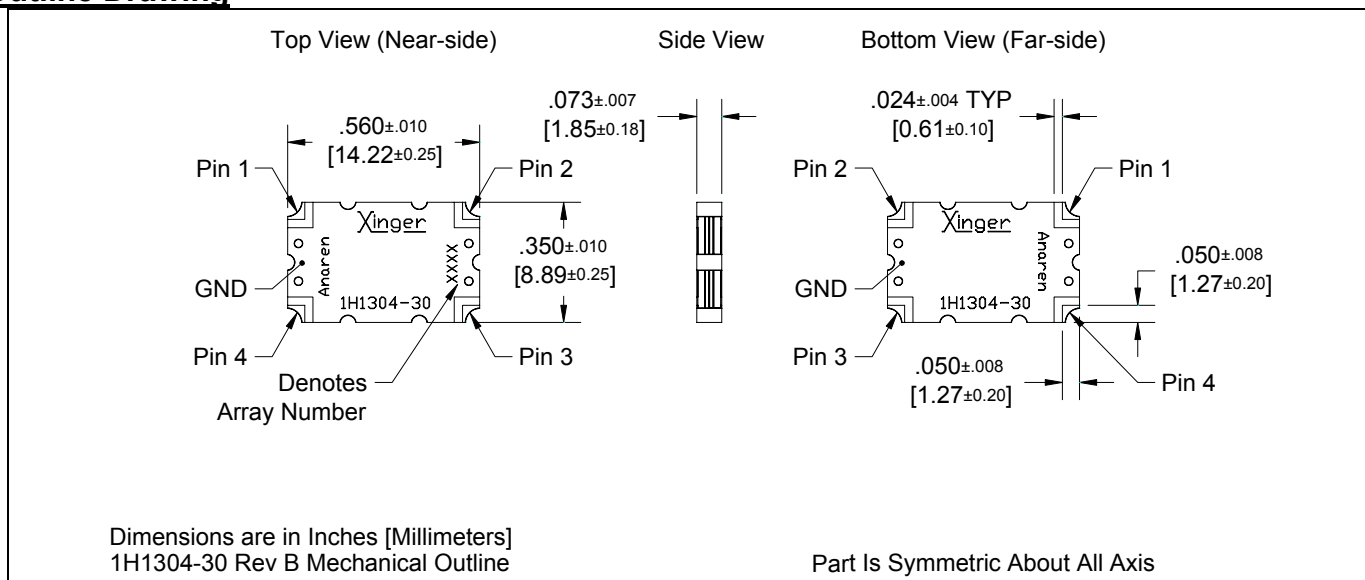

### Typical Performance: 700 MHz. to 1300 MHz.

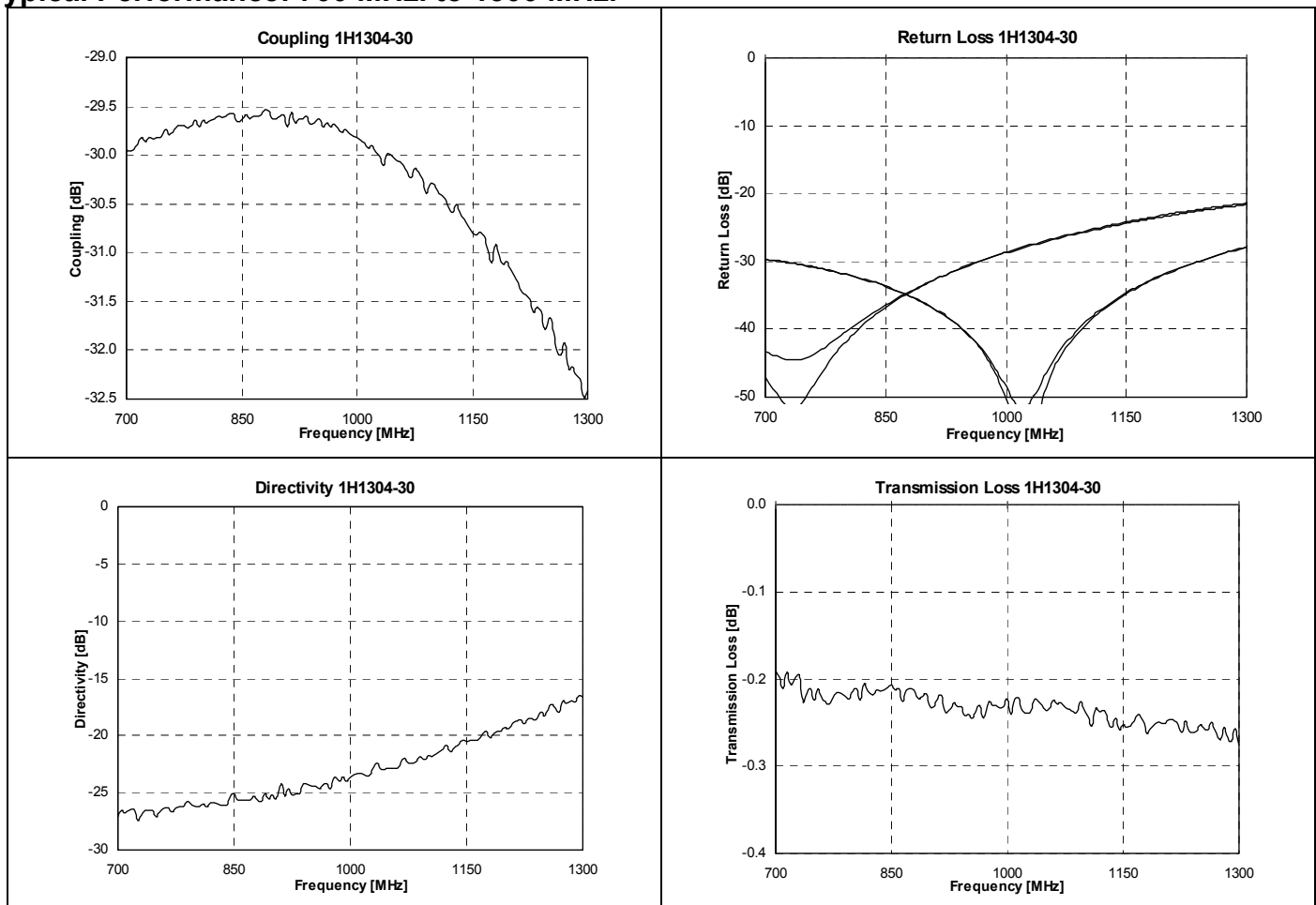

### Pin Configuration

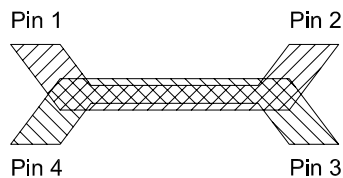

Directional Coupler Pin Configuration

	Pin 1	Pin 2	Pin 3	Pin 4
Configuration #1	Input	Output	Isolated	Coupled
Configuration #2	Output	Input	Coupled	Isolated
Configuration #3	Isolated	Coupled	Input	Output
Configuration #4	Coupled	Isolated	Output	Input

### Mounting Footprint

To ensure proper electrical and thermal performance there must be a ground plane with 100% solder connection underneath the part

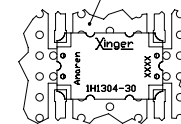

Part Is Symmetric About All Axis

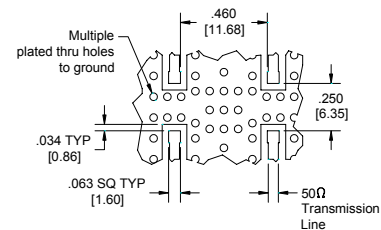

Dimensions are in Inches [Millimeters]  
1H1304-30 Rev B Mounting Footprint

USA/Canada: (315) 432-8909  
Toll Free: (800) 544-2414  
Europe: +44 2392-232392

Available on Tape and Reel For Pick and Place Manufacturing.



### Carrier Tape

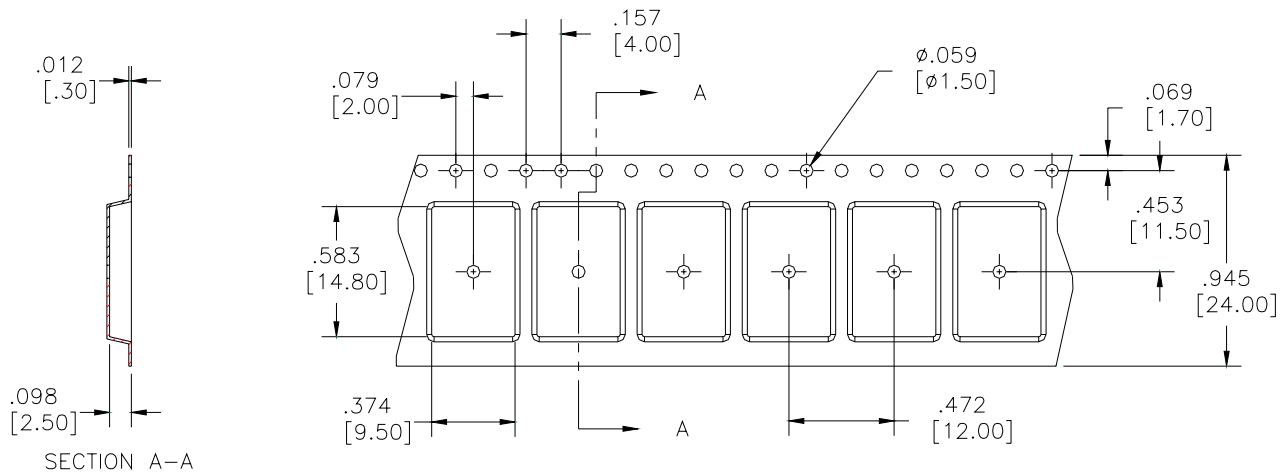

### Reel

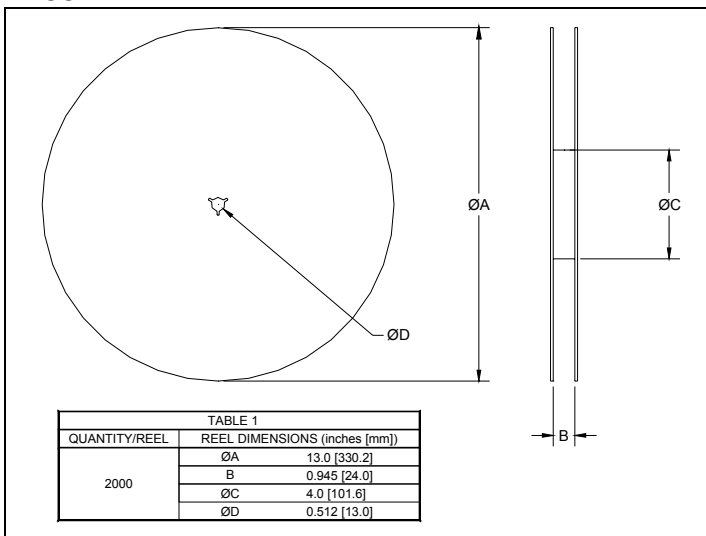

- Parts are available in both reel and tube
- Quantity of 30 parts available per tube

