

#### MIRELLA-50-S-PIN

~15° spot beam

#### TECHNICAL SPECIFICATIONS:

Dimensions	Ø 49.9 mm
Height	23.9 mm
Fastening	pin
Colour	metal
Box size	480 x 280 x 300 mm
Box weight	2.7 kg
Quantity in Box	336 pcs
ROHS compliant	yes ⓘ







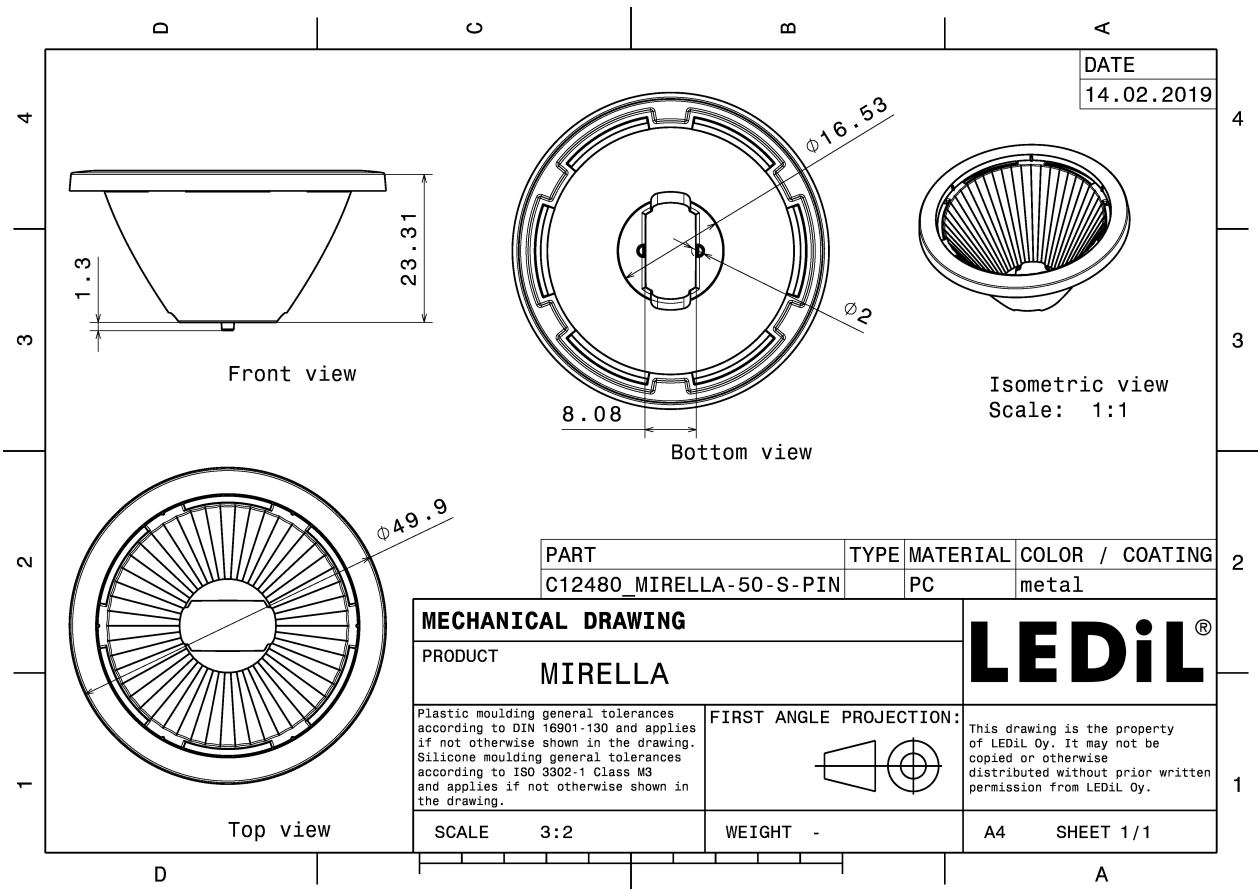

#### MATERIAL SPECIFICATIONS:

Component	Type	Material	Colour	Coating
MIRELLA-50-S-PIN	Reflector	PC	metal	lacquer

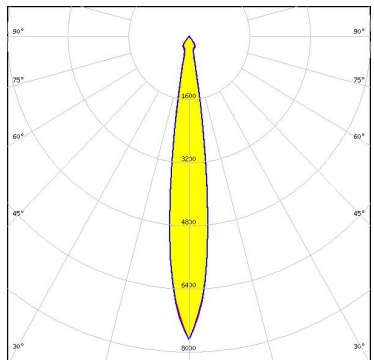

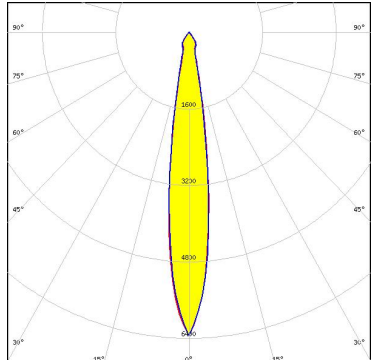
#### PHOTOMETRIC DATA (MEASURED):

<p>bridgelux.</p> <p>LED SM4            FWHM 15.0°            Efficiency 81 %            Peak intensity 6.930 cd/m            LEDs/each optic 1            Light colour White            Required components:            C12479_MIRELLA-DL</p>		
<p><b>CREE</b> ⇄</p> <p>LED MHB-A/B            FWHM 16.0°            Efficiency 85 %            Peak intensity 7.000 cd/m            LEDs/each optic 1            Light colour White            Required components:            C13333_MIRELLA-CL</p>		
<p><b>CREE</b> ⇄</p> <p>LED MHB-A/B            FWHM 17.0°            Efficiency 85 %            Peak intensity 5.430 cd/m            LEDs/each optic 1            Light colour White            Required components:            C12479_MIRELLA-DL</p>		
<p><b>CREE</b> ⇄</p> <p>LED MHB-A/B            FWHM 14.0°            Efficiency 90 %            Peak intensity 9.360 cd/m            LEDs/each optic 1            Light colour White            Required components:</p>		

#### PHOTOMETRIC DATA (MEASURED):



LED XHP50  
 FWHM 14.0°  
 Efficiency 88 %  
 Peak intensity 7.000 cd/lm  
 LEDs/each optic 1  
 Light colour White  
 Required components:  
 C13333\_MIRELLA-CL

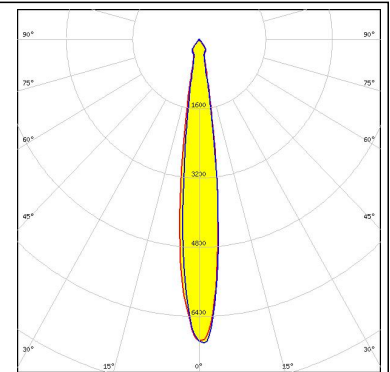

LED XHP50  
 FWHM 16.0°  
 Efficiency 89 %  
 Peak intensity 5.300 cd/lm  
 LEDs/each optic 1  
 Light colour White  
 Required components:  
 C12479\_MIRELLA-DL

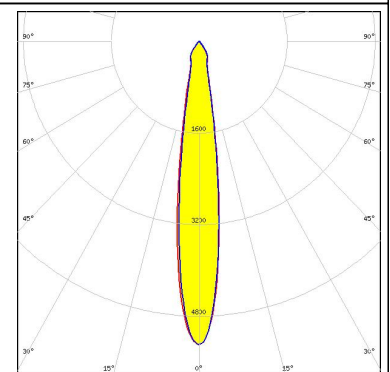

LED XHP50  
 FWHM 13.0°  
 Efficiency 93 %  
 Peak intensity 8.800 cd/lm  
 LEDs/each optic 1  
 Light colour White  
 Required components:

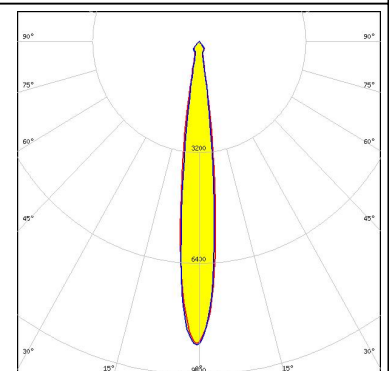
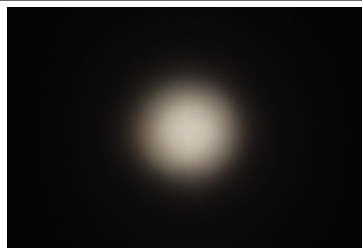

LED XHP50  
 FWHM 22.0°  
 Efficiency 86 %  
 Peak intensity 2.800 cd/lm  
 LEDs/each optic 1  
 Light colour White  
 Required components:  
 C13723\_MIRELLA-RZL

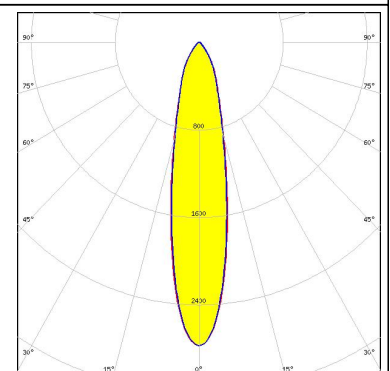
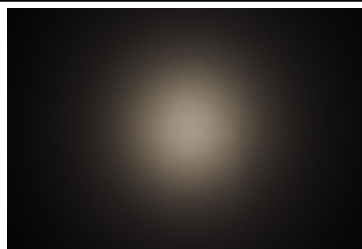

#### PHOTOMETRIC DATA (MEASURED):

#### CREE

LED XM-L  
 FWHM 8.7°  
 Efficiency 90 %  
 Peak intensity 19.340 cd/lm  
 LEDs/each optic 1  
 Light colour White  
 Required components:

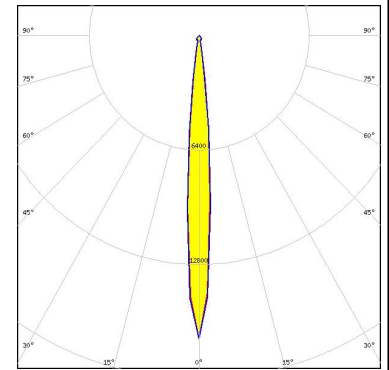
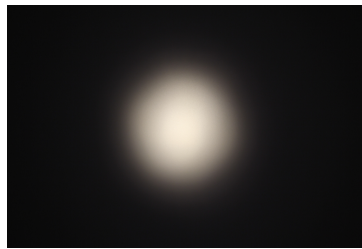

#### CREE

LED XM-L  
 FWHM 12.0°  
 Efficiency 85 %  
 Peak intensity 11.380 cd/lm  
 LEDs/each optic 1  
 Light colour White  
 Required components:  
 C13333\_MIRELLA-CL



#### CREE

LED XM-L  
 FWHM 12.0°  
 Efficiency 86 %  
 Peak intensity 8.730 cd/lm  
 LEDs/each optic 1  
 Light colour White  
 Required components:  
 C12479\_MIRELLA-DL



#### CREE

LED XM-L RGB  
 FWHM 21.0°  
 Efficiency 84 %  
 Peak intensity 3.350 cd/lm  
 LEDs/each optic 1  
 Light colour White  
 Required components:  
 C13723\_MIRELLA-RZL

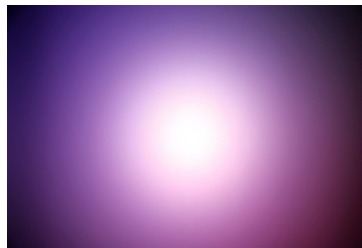

#### PHOTOMETRIC DATA (MEASURED):

#### CREE

LED XM-L2  
FWHM 12.0°  
Efficiency 86 %  
Peak intensity 8.190 cd/lm  
LEDs/each optic 1  
Light colour White  
Required components:  
C12479\_MIRELLA-DL



#### CREE

LED XM-L2  
FWHM 8.6°  
Efficiency 91 %  
Peak intensity 18.940 cd/lm  
LEDs/each optic 1  
Light colour White  
Required components:

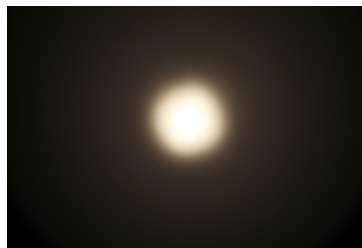

#### CREE

LED XP-G  
FWHM 11.0°  
Efficiency 86 %  
Peak intensity 10.360 cd/lm  
LEDs/each optic 1  
Light colour White  
Required components:  
C12479\_MIRELLA-DL

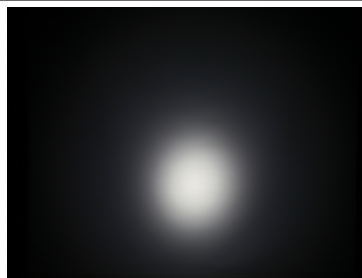

#### CREE

LED XP-G  
FWHM 8.1°  
Efficiency 91 %  
Peak intensity 24.980 cd/lm  
LEDs/each optic 1  
Light colour White  
Required components:



#### PHOTOMETRIC DATA (MEASURED):

#### CREE

LED XP-G  
 FWHM 11.0°  
 Efficiency 86 %  
 Peak intensity 14.120 cd/lm  
 LEDs/each optic 1  
 Light colour White  
 Required components:  
 C13333\_MIRELLA-CL



#### CREE

LED XP-G2  
 FWHM 11.0°  
 Efficiency 87 %  
 Peak intensity 10.360 cd/lm  
 LEDs/each optic 1  
 Light colour White  
 Required components:  
 C12479\_MIRELLA-DL



#### CREE

LED XP-G2  
 FWHM 7.9°  
 Efficiency 91 %  
 Peak intensity 25.060 cd/lm  
 LEDs/each optic 1  
 Light colour White  
 Required components:

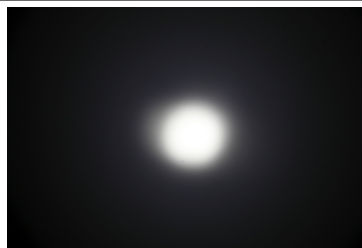

#### CREE

LED XP-L HI  
 FWHM 7.7°  
 Efficiency 90 %  
 Peak intensity 24.900 cd/lm  
 LEDs/each optic 1  
 Light colour White  
 Required components:

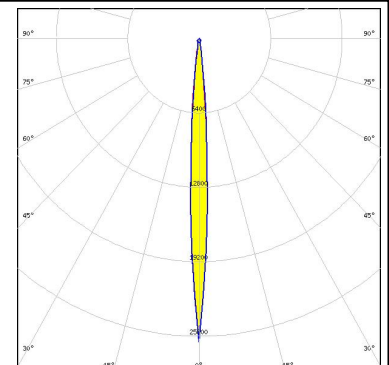
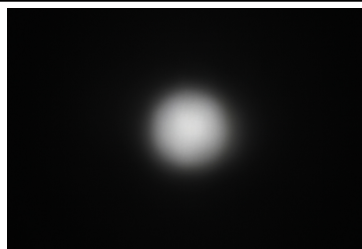

#### PHOTOMETRIC DATA (MEASURED):

#### CREE

LED XT-E  
 FWHM 10.0°  
 Efficiency 84 %  
 Peak intensity 14.100 cd/lm  
 LEDs/each optic 1  
 Light colour White  
 Required components:  
 C13333\_MIRELLA-CL



#### CREE

LED XT-E  
 FWHM 11.0°  
 Efficiency 85 %  
 Peak intensity 9.910 cd/lm  
 LEDs/each optic 1  
 Light colour White  
 Required components:  
 C12479\_MIRELLA-DL



#### CREE

LED XT-E  
 FWHM 7.6°  
 Efficiency 89 %  
 Peak intensity 23.980 cd/lm  
 LEDs/each optic 1  
 Light colour White  
 Required components:



#### LUMILEDS

LED LUXEON 5050 Round LES  
 FWHM 11.0°  
 Efficiency 93 %  
 Peak intensity 11.900 cd/lm  
 LEDs/each optic 1  
 Light colour White  
 Required components:

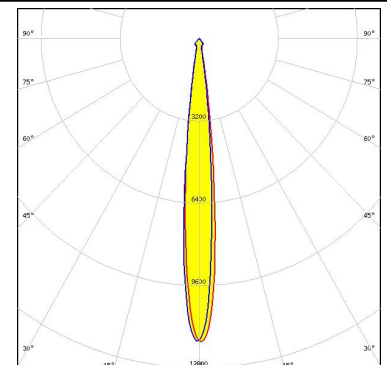
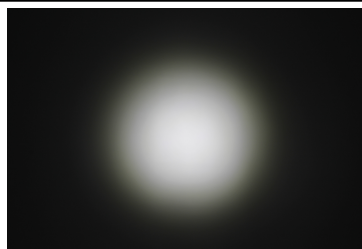

#### PHOTOMETRIC DATA (MEASURED):

##### LUMILEDS

LED LUXEON A  
 FWHM 12.0°  
 Efficiency 85 %  
 Peak intensity 8.890 cd/lm  
 LEDs/each optic 1  
 Light colour White  
 Required components:  
 C12479\_MIRELLA-DL



##### LUMILEDS

LED LUXEON A  
 FWHM 10.0°  
 Efficiency 85 %  
 Peak intensity 14.520 cd/lm  
 LEDs/each optic 1  
 Light colour White  
 Required components:  
 C13333\_MIRELLA-CL



##### LUMILEDS

LED LUXEON A  
 FWHM 8.9°  
 Efficiency 89 %  
 Peak intensity 20.540 cd/lm  
 LEDs/each optic 1  
 Light colour White  
 Required components:





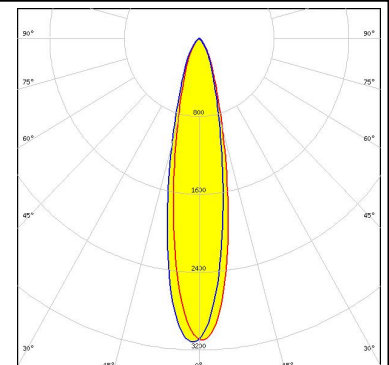
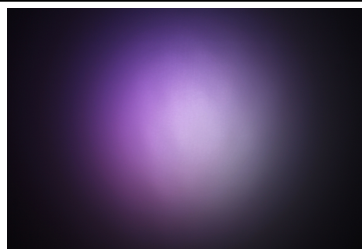

##### LUMILEDS

LED LUXEON C  
 FWHM 22.0°  
 Efficiency 81 %  
 Peak intensity 3.130 cd/lm  
 LEDs/each optic 4  
 Light colour RGBW  
 Required components:  
 C13723\_MIRELLA-RZL

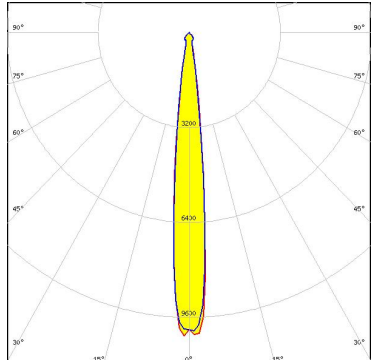

**PHOTOMETRIC DATA (MEASURED):**

<p><b>LUMILEDS</b></p> <p>LED LUXEON M/MX            FWHM 15.0°            Efficiency 86 %            Peak intensity 5.880 cd/m            LEDs/each optic 1            Light colour White            Required components:            C12479_MIRELLA-DL</p>		
<p><b>LUMILEDS</b></p> <p>LED LUXEON M/MX            FWHM 15.0°            Efficiency 85 %            Peak intensity 7.240 cd/m            LEDs/each optic 1            Light colour White            Required components:            C13333_MIRELLA-CL</p>		
<p><b>LUMILEDS</b></p> <p>LED LUXEON M/MX            FWHM 12.0°            Efficiency 91 %            Peak intensity 10.310 cd/m            LEDs/each optic 1            Light colour White            Required components:</p>		
<p><b>LUMILEDS</b></p> <p>LED LUXEON MZ            FWHM 11.0°            Efficiency 85 %            Peak intensity 9.250 cd/m            LEDs/each optic 1            Light colour White            Required components:            C12479_MIRELLA-DL</p>		

#### PHOTOMETRIC DATA (MEASURED):

##### LUMILEDS

LED LUXEON MZ  
FWHM 8.7°  
Efficiency 90 %  
Peak intensity 19.280 cd/lm  
LEDs/each optic 1  
Light colour White  
Required components:

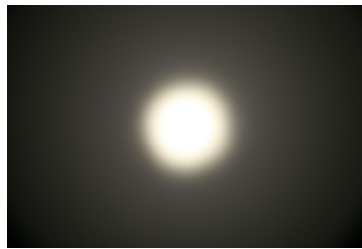

##### LUMILEDS

LED LUXEON Z  
FWHM 18.0°  
Efficiency 82 %  
Peak intensity 3.400 cd/lm  
LEDs/each optic 4  
Light colour RGBW  
Required components:  
C13723\_MIRELLA-RZL

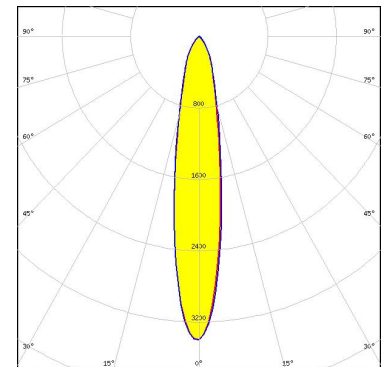
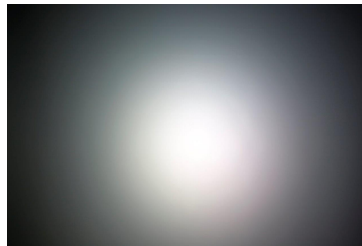

##### NICHIA

LED NS9x383  
FWHM 9.2°  
Efficiency 89 %  
Peak intensity 17.740 cd/lm  
LEDs/each optic 1  
Light colour White  
Required components:

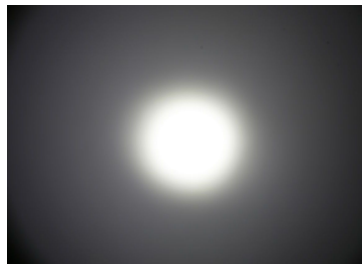





##### NICHIA

LED NS9x383  
FWHM 12.0°  
Efficiency 85 %  
Peak intensity 8.430 cd/lm  
LEDs/each optic 1  
Light colour White  
Required components:  
C12479\_MIRELLA-DL

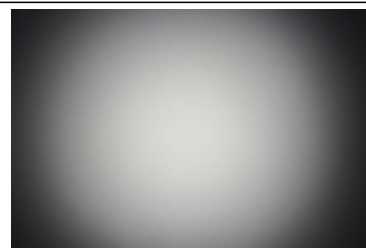
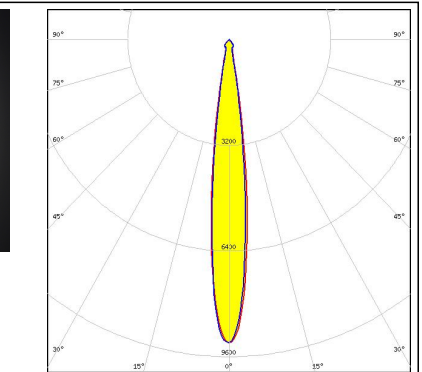

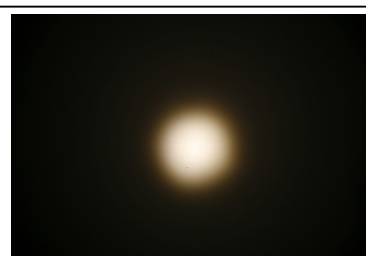
#### PHOTOMETRIC DATA (MEASURED):

<p><b>NICHIA</b></p> <p>LED NV4x144A            FWHM 13.0°            Efficiency 92 %            Peak intensity 9.200 cd/lm            LEDs/each optic 1            Light colour White            Required components:</p>		
<p><b>OSRAM</b>  <small>Opto Semiconductors</small></p> <p>LED Duris S8            FWHM 9.7°            Efficiency 91 %            Peak intensity 16.040 cd/lm            LEDs/each optic 1            Light colour White            Required components:</p>		
<p><b>OSRAM</b>  <small>Opto Semiconductors</small></p> <p>LED Duris S8            FWHM 11.0°            Efficiency 86 %            Peak intensity 11.600 cd/lm            LEDs/each optic 1            Light colour White            Required components:            C13333_MIRELLA-CL</p>		
<p><b>OSRAM</b>  <small>Opto Semiconductors</small></p> <p>LED Duris S8            FWHM 12.0°            Efficiency 86 %            Peak intensity 8.300 cd/lm            LEDs/each optic 1            Light colour White            Required components:            C12479_MIRELLA-DL</p>		

#### PHOTOMETRIC DATA (MEASURED):

##### OSRAM

Opto Semiconductors

LED OSLON Square EC  
FWHM 11.0°  
Efficiency 85 %  
Peak intensity 9.700 cd/lm  
LEDs/each optic 1  
Light colour White  
Required components:  
C12479\_MIRELLA-DL



##### OSRAM

Opto Semiconductors

LED OSLON Square EC  
FWHM 8.0°  
Efficiency 90 %  
Peak intensity 23.550 cd/lm  
LEDs/each optic 1  
Light colour White  
Required components:



##### OSRAM

Opto Semiconductors

LED OSLON Square EC  
FWHM 9.4°  
Efficiency 85 %  
Peak intensity 15.380 cd/lm  
LEDs/each optic 1  
Light colour White  
Required components:  
C13333\_MIRELLA-CL



##### OSRAM

Opto Semiconductors

LED Ostar-SMT RGB  
FWHM 19.0°  
Efficiency 85 %  
Peak intensity 3.710 cd/lm  
LEDs/each optic 1  
Light colour White  
Required components:  
C13723\_MIRELLA-RZL

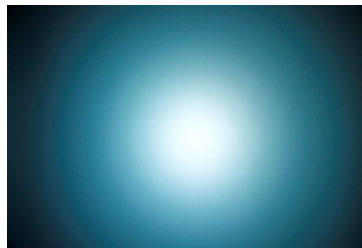

#### PHOTOMETRIC DATA (MEASURED):

#### SAMSUNG

LED LH508A  
 FWHM 12.0°  
 Efficiency 90 %  
 Peak intensity 10.500 cd/lm  
 LEDs/each optic 1  
 Light colour White  
 Required components:

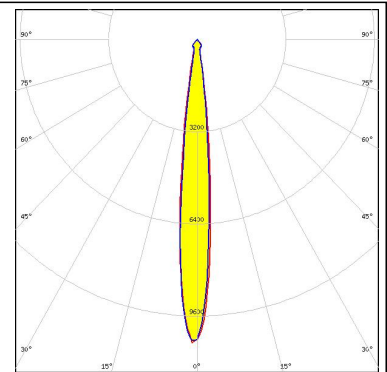

SEOUL SEMICONDUCTOR  
 LED F50360 (RGB)  
 FWHM 21.0°  
 Efficiency 84 %  
 Peak intensity 3.300 cd/lm  
 LEDs/each optic 1  
 Light colour White  
 Required components:  
 C13723\_MIRELLA-RZL

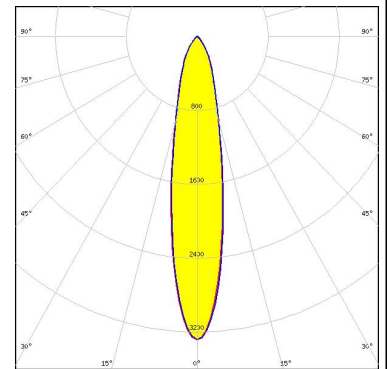
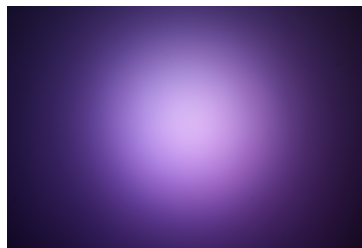

SEOUL SEMICONDUCTOR  
 LED F50360 (RGB)  
 FWHM 19.0°  
 Efficiency 86 %  
 Peak intensity 3.750 cd/lm  
 LEDs/each optic 1  
 Light colour White  
 Required components:  
 C13723\_MIRELLA-RZL

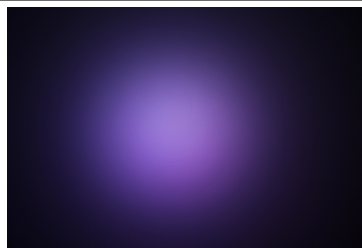

#### PHOTOMETRIC DATA (SIMULATED):



LED XHP35 HD  
 FWHM 11.0°  
 Efficiency 92 %  
 Peak intensity 11.800 cd/lm  
 LEDs/each optic 1  
 Light colour White  
 Required components:

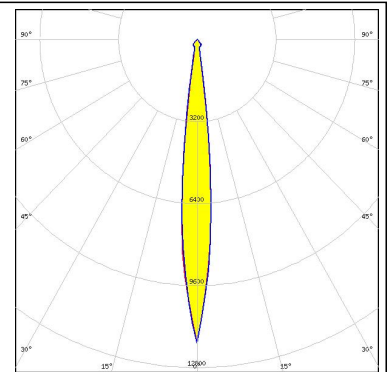

LED LUXEON 5258  
 FWHM 9.0°  
 Efficiency 91 %  
 Peak intensity 17.000 cd/lm  
 LEDs/each optic 1  
 Light colour White  
 Required components:

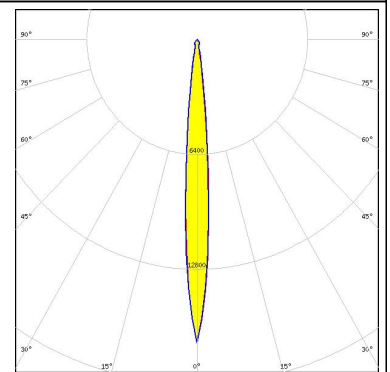

LED OSCONIQ P 7070  
 FWHM 11.0°  
 Efficiency 87 %  
 Peak intensity 10.410 cd/lm  
 LEDs/each optic 1  
 Light colour White  
 Required components:  
 C13333\_MIRELLA-CL

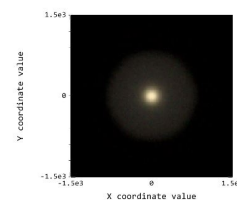

Detector Image: Illuminance  
 OSRAM\_MIRELLA-50-S-PIN-CL-30000\_PSR-200  
 Configuration: 1 of 2

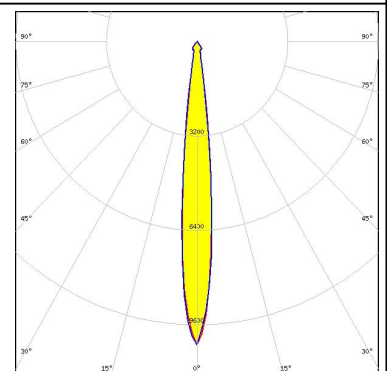

LED OSCONIQ P 7070  
 FWHM 10.0°  
 Efficiency 92 %  
 Peak intensity 11.600 cd/lm  
 LEDs/each optic 1  
 Light colour White  
 Required components:

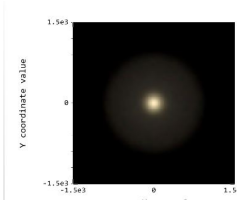

Detector Image: Illuminance  
 OSRAM\_MIRELLA-50-S-PIN-CL-30000\_PSR-200  
 Configuration: 1 of 2

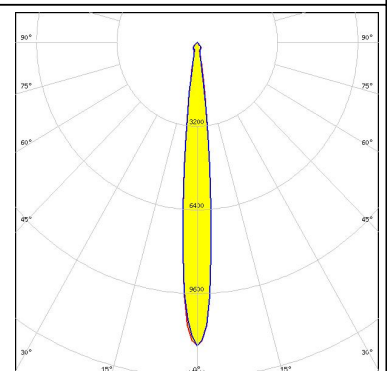

#### PHOTOMETRIC DATA (SIMULATED):

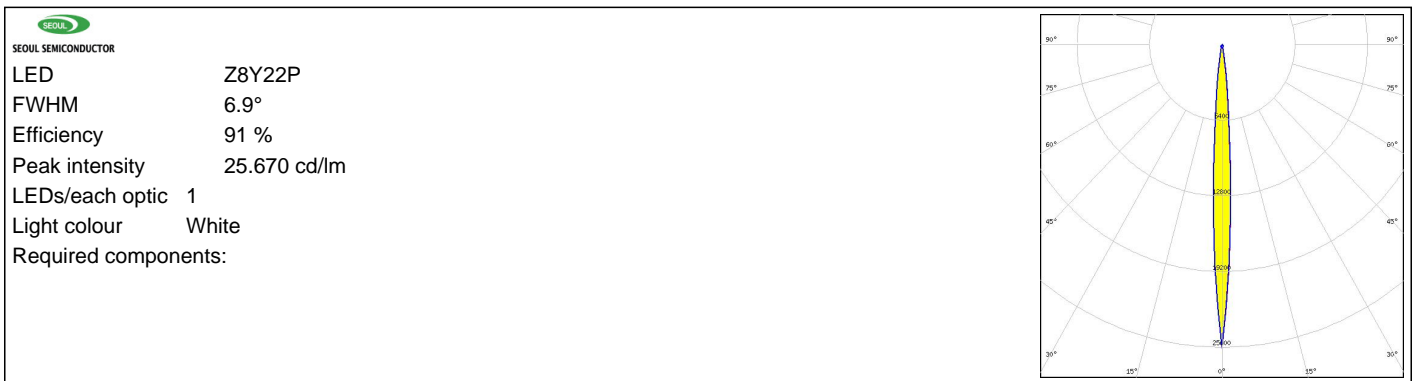

#### GENERAL INFORMATION:

NOTE: The typical beam angle will be changed by different color, chip size and chip position tolerance. The typical total beam angle is the full angle measured where the luminous intensity is half of the peak value.

#### MATERIALS:

As part of our continuous research and improvement processes, and to ensure the best possible quality and availability of our products, LEDiL reserves the right to change material grades without notice.

#### PRODUCT DATA USER AGREEMENT AND DISCLAIMER:

The measured data in the provided downloadable LEDiL Product Datasheets and Mechanical 2D-Drawings is rounded and provided as reference for planning. LEDiL Oy's optical specifications have been verified by conducting performance testing of the products in accordance with the company's quality system. The reported data are averaged results of multiple measurements with typical variation. LEDiL Oy reserves the right to without prior notification make changes and improvements to its products.

LEDiL Oy assumes neither warranty, nor guarantee nor any other liability of any kind for the contents and correctness of the provided data. The provided data has been generated with highest diligence but the provided data may in reality not represent the complete possible variation range of all intrinsic parameters. Therefore, in certain cases a deviation from the provided data could occur.

LEDiL Oy reserves the right to undertake technical changes of its products without further notification which could lead to changes in the provided data. LEDiL Oy assumes no liability of any kind for the possible deviation from any provided data or any other damage resulting from the usage of the provided data.

The user agrees to this disclaimer and user agreement with the download or usage of the provided files.

#### LEDiL Oy

Joensuunkatu 13  
FI-24240 SALO  
Finland

#### LEDiL Inc.

228 West Page Street  
Suite D  
Sycamore IL 60178  
USA

#### Local sales and technical support

[www.ledil.com/  
where\\_to\\_buy](http://www.ledil.com/where_to_buy)

#### Shipping locations

Salo, Finland  
Hong Kong, China

#### Distribution Partners

[www.ledil.com/  
where\\_to\\_buy](http://www.ledil.com/where_to_buy)